



INSTALLATION GUIDE

Steni Colour
Steni Vision
Steni Nature

FACADE PANELS INSTALLED AS VENTIALTED CLADDING



LASTING EXPRESSIONS

Important information

- The panels are best stored indoors in original packaging. Optionally the panels can be stored outdoors under tarpaulin.
- During storage, the pallets must be placed on a flat surface.
- Check all panels before mounting and processing. Any damage or defects on panels that are mounted, cut, drilled or otherwise worked after receipt, is considered accepted by the customer.
- To maintain the terms of approvals, fire approvals and the warranty the installation guide must be followed.
- Deviating in mounting may result in the loss of warranty and damage may occur on the products and underlying constructions.
- The latest version of the installation instructions can always be downloaded from our website or obtained by contacting Steni AS.

Handling the panels

Panels must be strapped when transported.

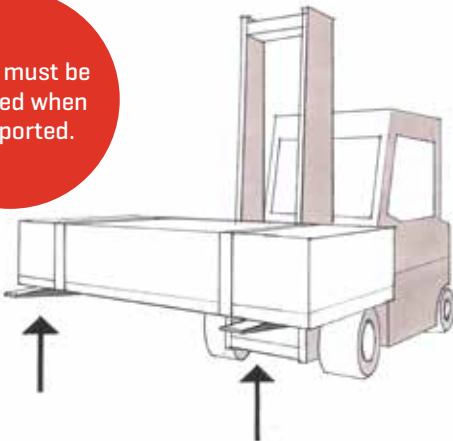

Lift the panels straight up without scratching.

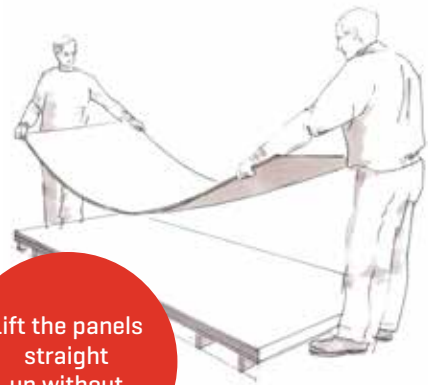

Carry the panels on its side.

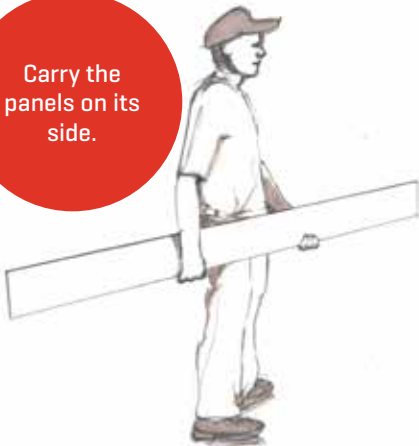

Large panels must be carried by two persons!

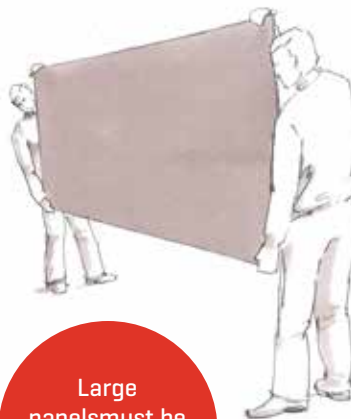

A vacuum lifter will be helpful in handling Steni Colour and Ateni Vision panels

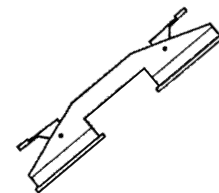

Environment and safety

ENVIRONMENT

- Steni panels are friendly to the environment and contain no harmful substances.
- The Products are included in the Nordic Swan ecolabel web portal* and approved for use in Swan labeled constructions.
- Steni products are registered in BVB, Basta and SundaHus and EPDs are available all products.
- More information is available on our website.



NEPD-2581-1309-EN
NEPD-2580-1307-EN
NEPD-2657-1361-EN

BYGGVARUBEDÖMNINGEN

*Steni panels can p.t. not formally receive the swan-label due to lack of classification criterion for this product category.

SAFETY

- Always work in a well-ventilated area or outdoors. If dust from cutting and drilling cannot be avoided use dust mask type P3 or better.
- Use tools connected to a vacuum cleaner when processing the panels.
- Wear safety goggles, gloves and other personal items safety equipment when handling and processing the panels.
- For more information. See our safety data sheet which can always be found on our website.

Advice on safe installation

GENERALLY

Take controlled measurements of walls and panels before mounting. Any deviations from measurements should be distributed over several panels so that the joints become even and continuous.

Dimensional tolerances for the various products can be found in our technical data sheet.

INSTALLING DIRECTION

For Steni Color with dark colors we recommend for aesthetic reasons that the panels are mounted in the same direction. [see arrow --> on the backside of the panel].

JOINTS BETWEEN THE PANELS

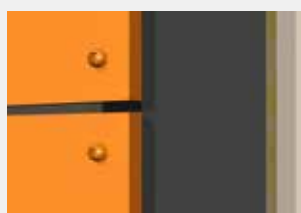

EPDM must cover the entire wooden batten



EPDM is optional on metal framing

JOINT OPENINGS:

Steni panels are normally mounted with 5 mm horizontal and vertical open joints.

If joint profiles are used the joint distance is to be increased to 10 mm.

A spacer block with grooves for the profile will ensure that the profile is placed central in the joint.

The panels must never be mounted .

Advice on safe installation

CUTTING AND DRILLING ON BUILDING SITE



Steni Colour og Steni Vision is cut frontside up.
Steni Nature is cut backside up.
Use a track-saw and a Steni cutting disc for best results.
Recommended speed on the cutting disc is min. 3000 rpm.

Drilling is done using a Steni multiconstruction drill bit.
The hole diameter must be min. 1,5 x screw diameter.

Minimum distance from panel edge to the hole is 15mm.
The distance between the holes should be max. 300 mm (se ill)

Dust from cutting and drilling must be removed immediately.

We recommend using tools connected to a dust extractor.
Any remaining dust is removed using compressed air and a soft dry brush. Do not rub. Dust that can not be blown away can be removed using a microfiber cloth dampened with an alkaline cleaning agent.

For more information see p 14.

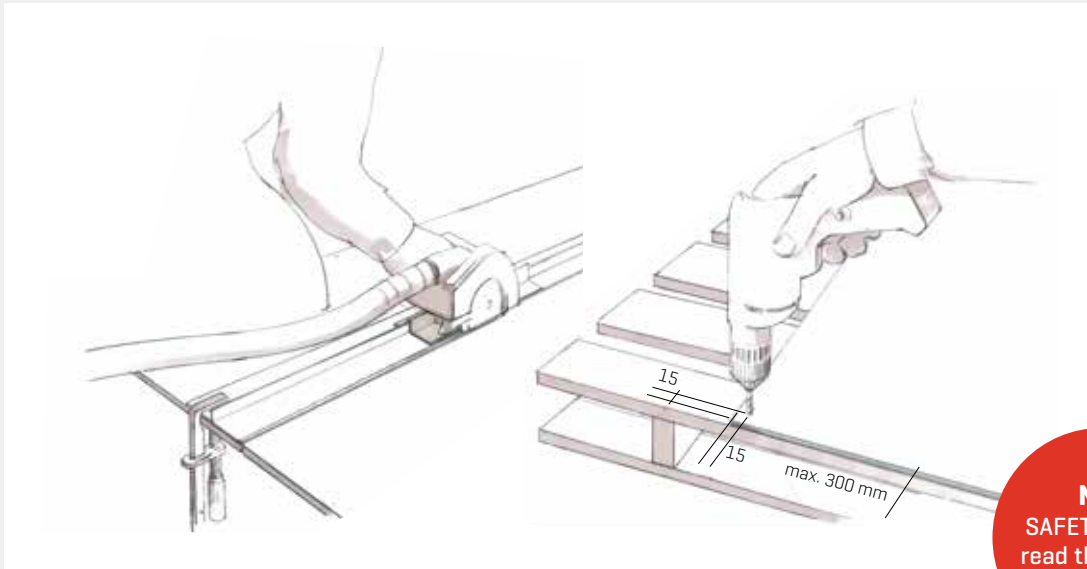

NB!
SAFETY FIRST.
read the safety
datasheet.

Steni recommend using a plunge saw with a track and dust extraction. Recommended saw depth is panel thickness + 5-7 mm
Steni cutting discs fits saws with the following spindle diameters
Ø30 mm Ø25,4 mm Ø22,2 mm Ø20 mm
Remember to check the correct spindle diameter when ordering

EDGE PAINTING ON THE BUILDING SITE

We recommend using an acrylic paint intended for external use to paint the cut surface edges after adjusting/cutting the panels.

Follow the instruction "Edgepaint with roller" available on our website. Read the entire instruction before starting the work.

The surface must be clean, dry, and free of dust, grease, oil, and other contamination before application.

For the best results, we recommend washing the cut surface with an alkaline cleaning agent (pH 9+) before applying the paint.

We recommend using a hard or semi-hard foam rubber roller for smooth surfaces to apply the paint.

Remember to remove any paint blemishes before the surface dries.

Please note that the cut surface may have small pores and irregularities which, depending on the application method, may be difficult to cover with edge paint. These pores are not a defect in the product but occur naturally during production.

Battening

BATTENING

Steni facade panels are installed as ventilated cladding on wood or metal battens. For optimal results, the battens must be installed level and plumb. For more information on using battens, see pages 6 og 7.

Always consult the local building regulations to make sure the constuctions is in compliance with local rules and regulations.



Ventilated metal profile for vertical or horizontal intallation

BATTEN DISTANCING, AIR GAP AND JOINT PROFILES

Steni panels are intalled on battens with a maximum c/c distance of 600 mm. This applies for both horizontally and vertically installed battens.

For aesthetic reasons and to avoid panels sagging between the battens, we recommend using c/c 400mm between battens when installing the panels in ceilings.

The min. with of the batten at a panel joint is 70 mm.
The min. with between joints is 45 mm.

The battens must have be thick enought to create an air gap of min. 23 mm behind the panels.

The battens must be installed to allow an air gap of min. 40 - 50 cm² pr running mertre along the foundation and other details [see ill. below].

In areas prone to pounding rain we recommend increasing the air gap behind the panels to 36 mm and to use joint profiles to protect agains water penetration.

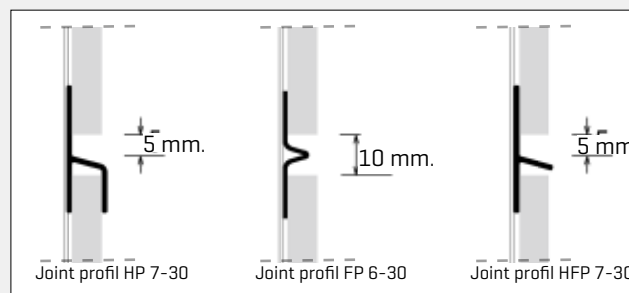

AIR GAP IN HORIZONTAL DETAILS

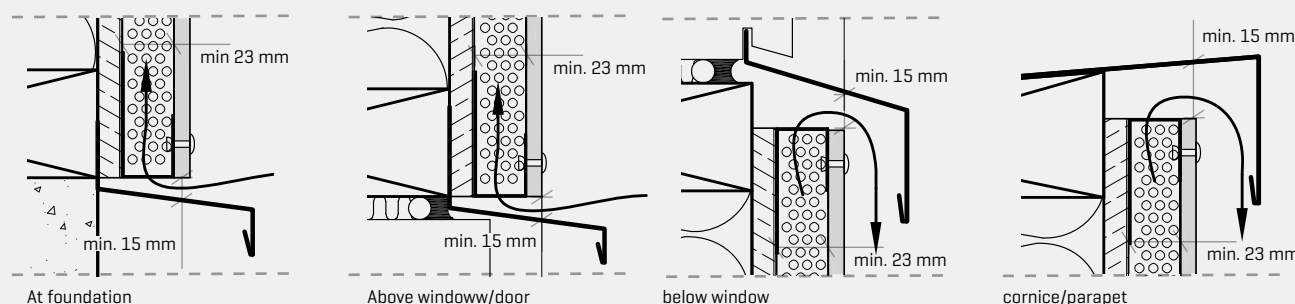

BATTEN DISTANCE

- maximum distance between wood and metal battens.

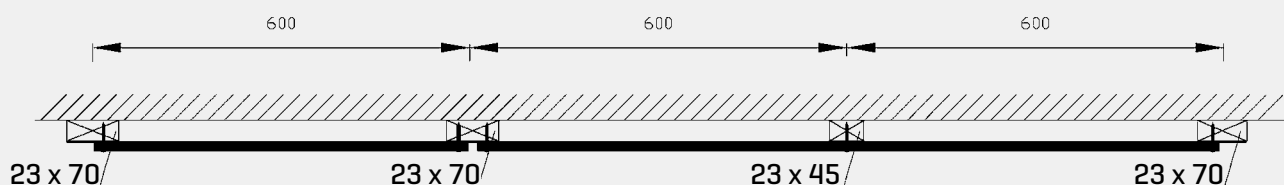

Batten dimentionis indicates min. size for wooden battens.

Battening

INSTALLATION ON WOODEN BATTENS

The battens can be both untreated or impregnated wood [max moisture content must not exceed 15-20%].



Before installing the panels the batten must be covered with Steni EPDM foil, stapled to the battens using a stapeling gun. The EPDM foil must be wider than the batten and cover the entire surface of the batten with an overhang of 10-20mm on each side. This is to prevent water from penetrating through the panel joints.

Steni wood screw shall be used for mechanical fixing. These screws are tested and adapted to our products and will help to ensure a good result.

While fixing, the crews must be centered in the hole. The torque on the screw drill must be adjusted so the screw head stops as it reaches the panel. Too much torque may damage the panel and reduce the pull out capacity of the screw. Do not countersink the screws.

Steni do not recommend combining adhesive systems with wooden battens. See FS400 for more information.

INSTALLATION ON METAL BATTENS

Follow the manufacturers guidelines when installing profiled metal battens, taking into account the prerequisites given on the previous pages regarding dimensions, distances and air gaps.

The use of EPDM is optional with metal battens. Tape or painted profiles can be used to cover bare metal in the joints.



Steni recommend using battens and panels of max 3 m. The batten length must be adapted to the panels and the design of the facade.

One or more panels can be installed on the same batten length.



The panels must never span a joint in the batten profile. Differences in the thermal expansion between panels and the metal can lead to stresses in the fixings and buckling of the panels on hot days.

Cutting of metal battens should not be done with tools developing heat. [angle grinders etc.] as this may damage the corrosion protection of the batten.

Steni metal screws shall be used for mechanical fixing. These screws are tested and adapted to our products and will help to ensure a good result for metal thicknesses up to 1 mm steel and 2 mm aluminium. The screw must be fixed in one continuous process. Start/stop motions can overload the screw head.

While fixing, the crews must be centered in the hole. The torque on the screw drill must be adjusted so the screw head stops as it reaches the panel. Too much torque may damage the panel and reduce the pull out capacity of the screw. Do not countersink the screws.



As an alternative to screws, blind rivets can be used.

When installing using adhesive systems follow the adhesive manufacturer's guidelines carefully. See FS400 for more information.

NOT RECOMMENDED

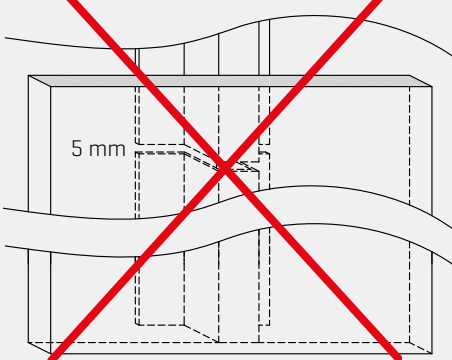

RECOMMENDED

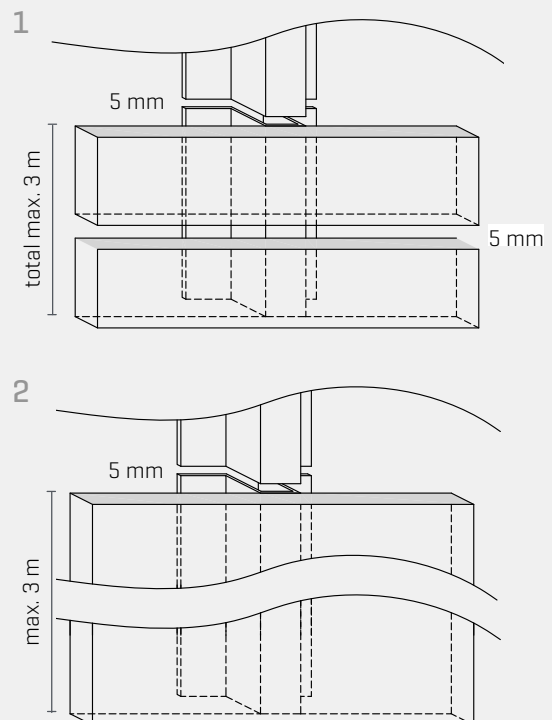

FS100 FLAT INSTALLATION USING MECHANICAL FIXINGS

INSTALLING STENI COLOUR, STENI VISION AND STENI NATURE

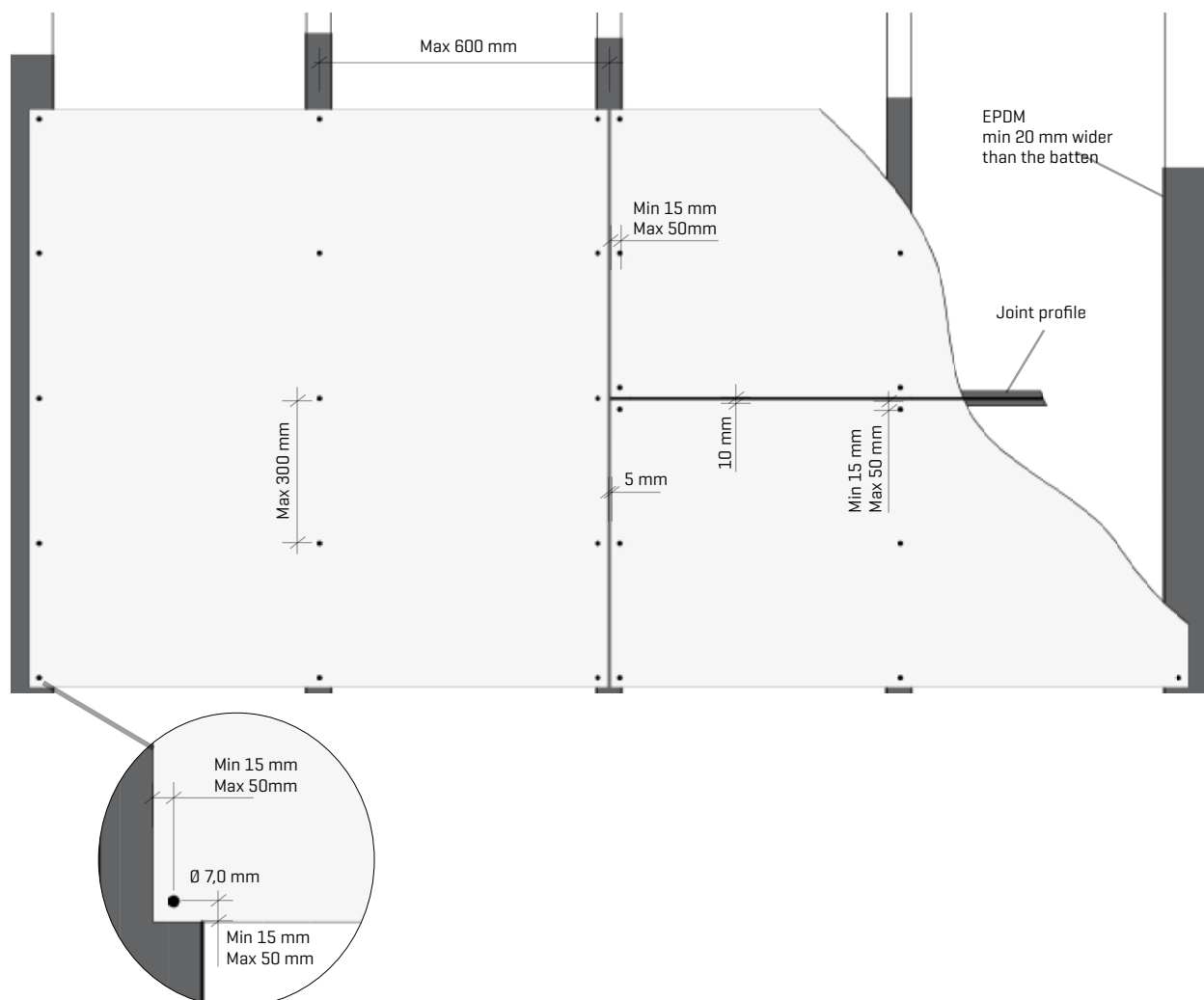

INSTALLATION SEQUENCE

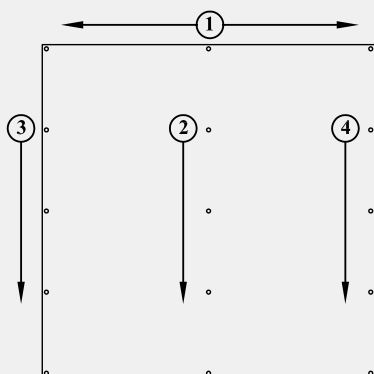

Steni recommends starting installing the panel from the top. Follow the sequence indicated in the illustration.

In this way the panels will hang straight, and it will be easier to get good results. Use Steni spacer blocks to ensure even joints.

When installing using joint profiles use a spacer with a groove to center the profile.

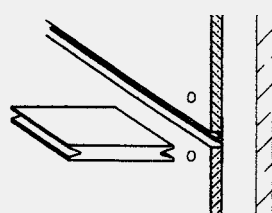

PREDRILLED HOLES

Steni can deliver panels with predrilled holes adapted to most designs and installation requirements. Steni will help you find a suitable drilling pattern for your project.

See our website for more information.

FS100 FLAT INSTALLATION USING POP-RIVETS

VERTICAL INSTALLATION

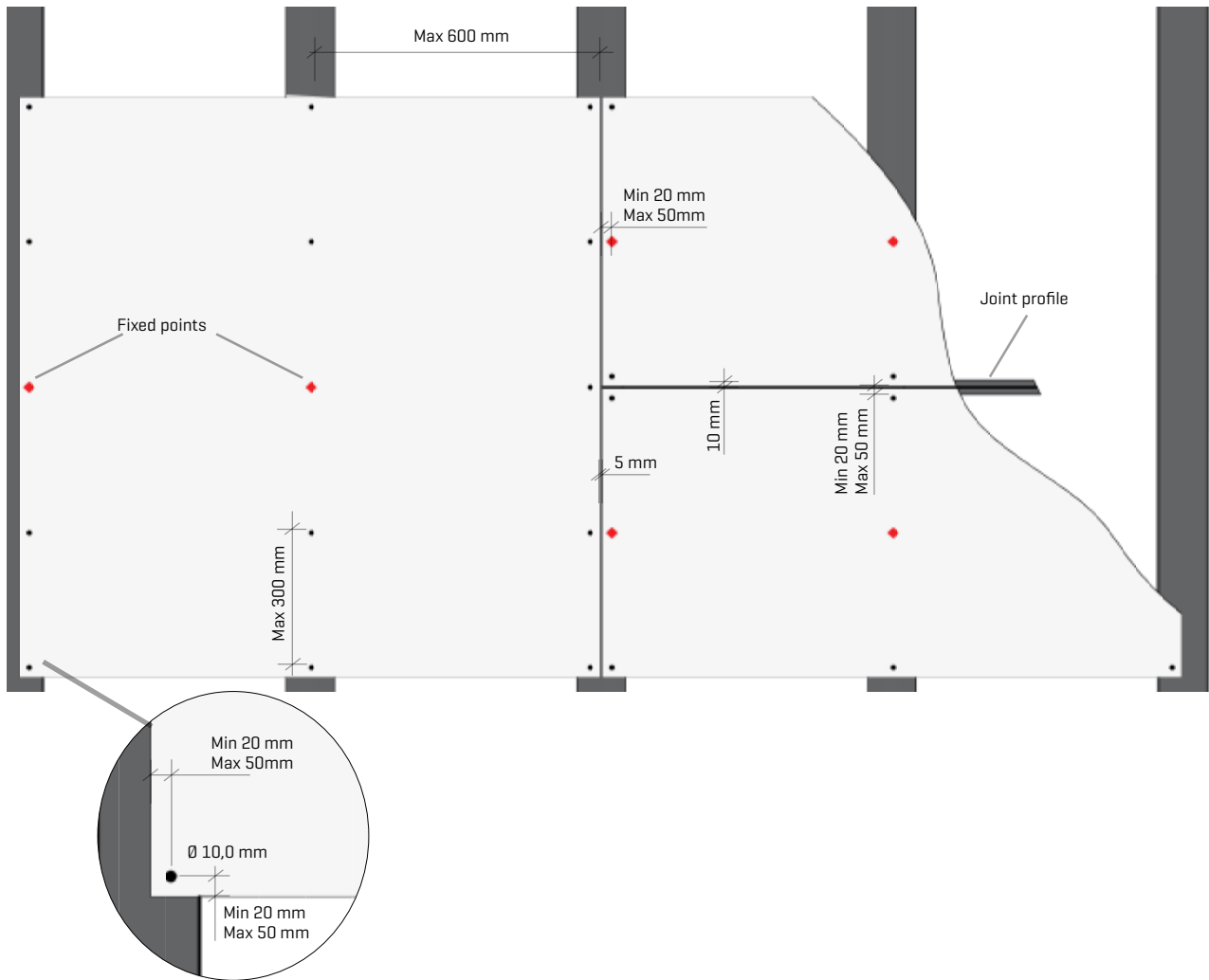

INSTALLATION SEQUENCE

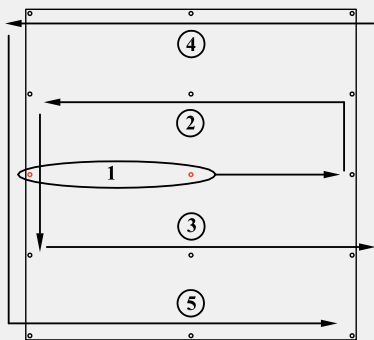

Steni recommends starting installing the panel by securing the two fixed points. Follow the sequence indicated in the illustration. Use our recommended nose part on the riveting tool to allow for panel movement.

Use Steni spacer blocks to ensure even joints [see ill. below]-----
When installing using joint profiles use a spacer with a groove to center the profile.

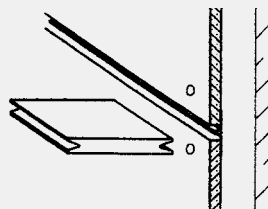

PREDRILLED HOLES

Steni can deliver panels with predrilled holes adapted to most designs and installation requirements. Steni will help you find a suitable drilling pattern for your project.

See our website for more information.



HORIZONTAL INSTALLATION

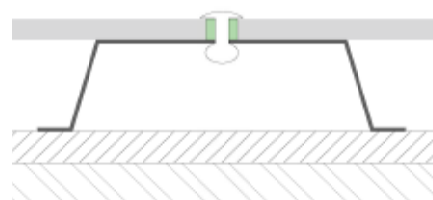
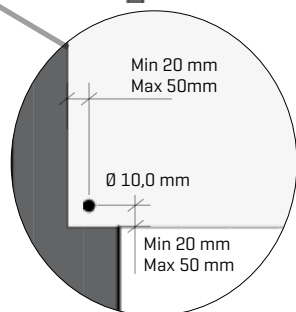
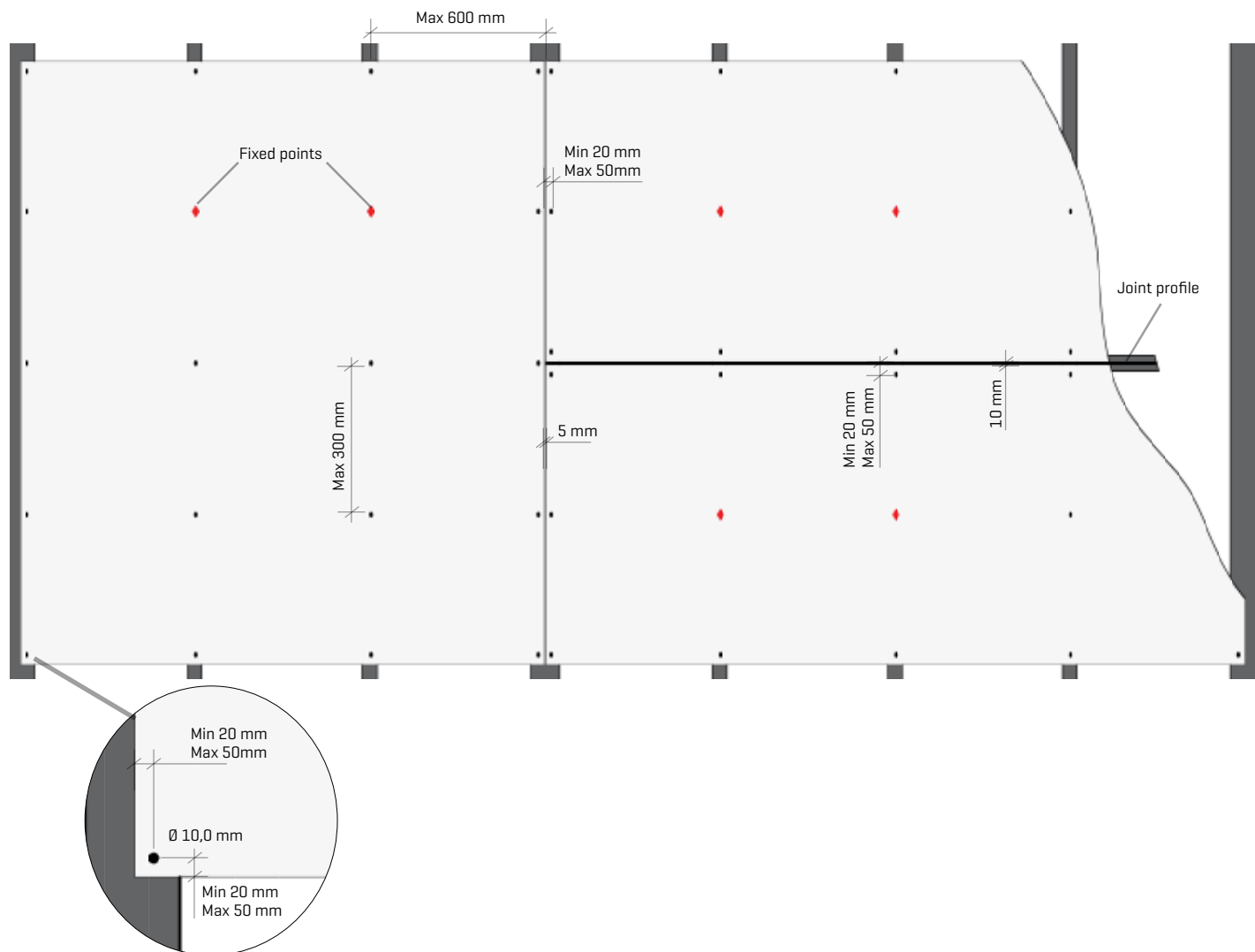

Installation of fixed points using fixation rings

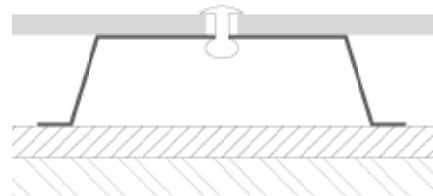

Installation of sliding points [no fixation ring]

We recommend corner profiles for a professional finish.

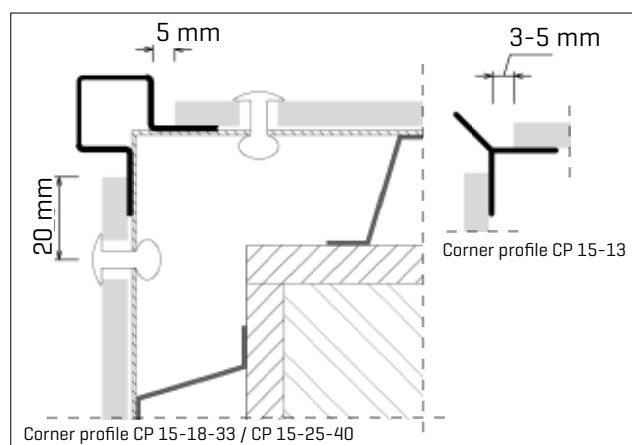

FS200

NARROW PANELS INSTALLED AS BEVEL SIDING

GENERAL

When installing panels using the FS200 system, vertical battens must be used. It is recommended to start with a small strip of panel at the base of the wall under the first panel to ensure you get the right starting angle [see ill].

Screw types and dimensions depend on the batten material and the width of the panels [see ill. below and on next page].

Steni recommend using our corner elements or our corner profile CP 15-25-40 on outside corners.

For Steni Colour and Steni Vision standard distance between battens apply.

For Steni Nature use a smaller distance [see next page].

The panels are installed with a vertical joint gap of 5 mm. This distance is also used between the panels and any profiles or other fixed installations. 

The FS200 system is not recommended for panels wider than 395 mm.

INSTALLATION PRINCIPLES

PANEL WIDTH: 196 MM

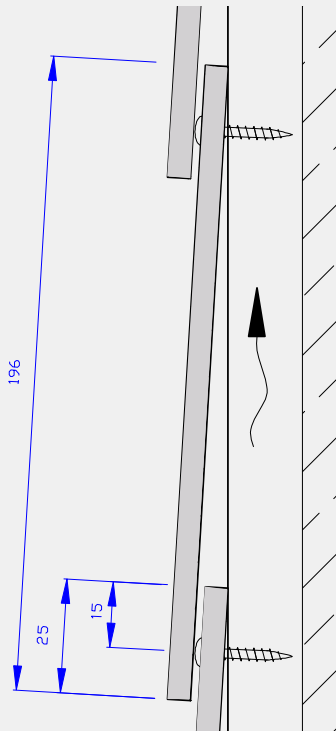

FIXINGS:

Use min. 28 mm long Steni wood screw or a Steni metal screw.

PANEL WIDTH: 200-395 MM

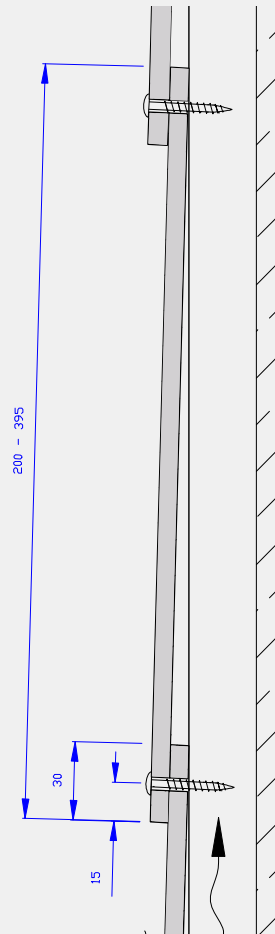

FIXINGS:

Use min. 32 mm long Steni wood screw or a Steni metal screw.

SPECIAL PROVISIONS WHEN INTALLING STENI NATURE

batten distance max. 450 mm [at 900 mm modules] and max. 400 mm [at 1200 mm modules]

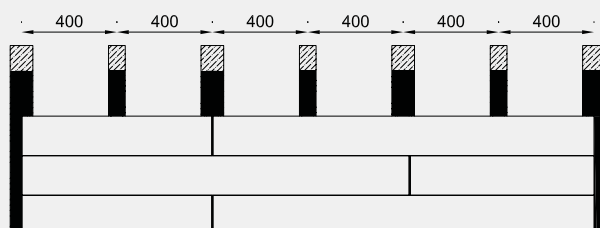

Batten distance at 1200 mm module [as seen from the front]

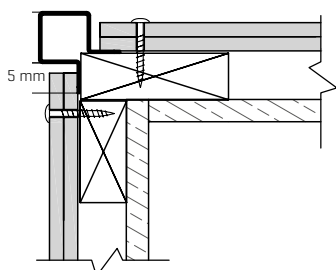

Outside corner with corner profile CP-15-25-40

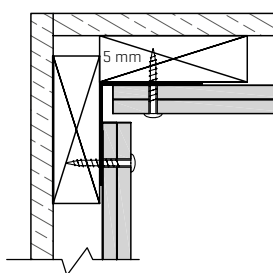

Inside corner with metal fitting

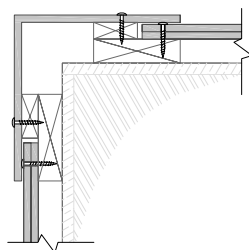

Outside corner with corner element

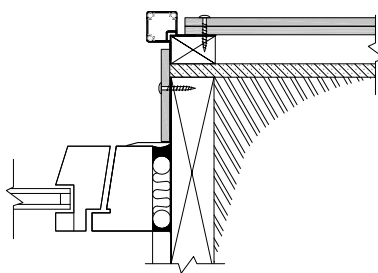

Exterior window reveal with corner profile CP-15-25-40



Start with a small strip of panel at the base.



FS 200 with corner element

FS400 FLAT INTALLATION USING ADHESIVES

STENI COLOUR AND STENI VISION



We recommend using metal battens with adhesives.

- Batten distance max c/c 600 mm. For ceiling applications we recommend c/c 400 mm.
- We recommend metal battens for best result.
- ! □ The metal must be protected against corrosion. Corrosion class C4 is minimum.
- If wooden battens are used we recommend planed spruce. The moisture content must not exceed 18%.
- Use only vertical battens with adhesives.
- ! □ Do not use EPDM with adhesives!
- Min batten width a panel joint is 100 mm.
- Min. batten width at other locations is 65 mm.
- Some adhesive systems can put limitations on the allowed panel size.
- Always follow the manufacturers instructions.
- In some cases mechanical fixings may be mandatory. consult the local building regulations in your area.

! □ Steni Nature will due to its surface have a tendency to warp more than what is recommended by the adhesive manufacturer. For this reason we do not recommend using adhesives with Steni Nature.

- The battens must be clean, dry and free from dust, grase and oil before applying the primer[3]. follow the manufacturers guide carefully.
- Avoid application and installation during rain or in situations with high humidity [fog etc.].
- Avoid conditions when moisture condenses on the surfaces where glue is to be applied. The surface temperature must be at least 3 °C higher than the dew point.
- Correct working temperature is between +5 °C og + 30 °C.
- The adhesive system is comrised of the following generic components [types and characteristics depends on the manufacturer. See manufacturers instructions.].

CLEANER

Cleaner is used for cleaning the surfaces where the tape[4] and the adhesive bead[3] is placed. Clean sn area of 10-15 cm along the entire panel length. Let the surfaces dry after application.

PRIMER

Primer is used to pretreat the surfaces prior to applying the adhesive [3] and the tape [4]. The primer must be allowed to dry according to the manufacturers instructions. Correct primer is depending on the types of surface [see manufacturers instructions].

ELASTIC ADHESIVE

The adhesive is applied on the batten in one continous string. For correct amount of adhesive use the nossle. If nothing is stated, apply the adhesive in a 10mm by 10 mm bead. Make sure there are no air in the adhesive bead..

Allow for min. 5 mm gap between the adhesive [3] and the tape [4].

DOUBLE SIDED FOAM TAPE

- The tape is used to fixate the panels while the adhesive [3] cures. We recommend you install the tape before you apply the adhesive.
- When the panels are installed position the panel by pressing it into the adhesive[3], but not into the tape[4].
- You can now adjust the panels position. The panel is fixated by pressing it into the tape[4].
- The installation is complete when the panel has made contact with the tape along the entire length.

PRINCIPLES FOR INSTALLING

Follow the adhesive manufacturers own instructions

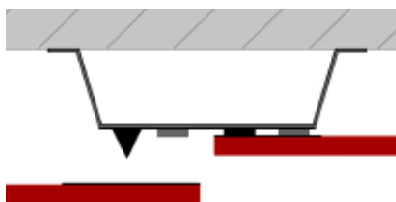

At panel joint - min. nominal width is 100 mm.

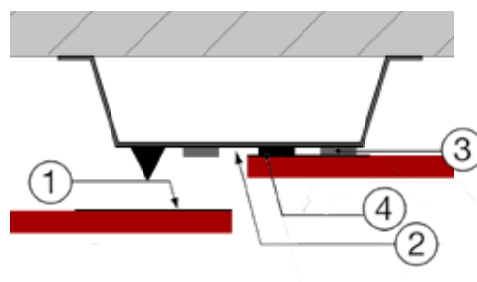

- 1: Cleaner
- 2: Primer
- 3: Elastic adhesive
- 4: Double sided foam tape

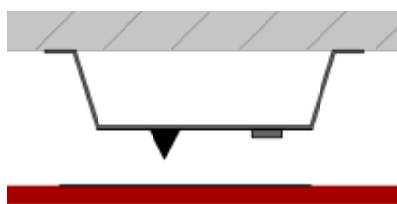

At panel field - min. nominal width is 65 mm.

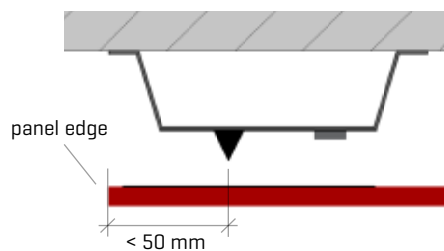

At panel edge - min. nominal width is 65 mm.
Max. overhang of the edge is 50 mm.



For all adhesive systems we refer to the manufacturers own intallation guides. Several adhesive manufacturers have products suitable for installing Steni panels. The adhesive system has to be tested and approved for use with our products prior to use. Information on approved adhesive systems can be found on our website.



INSTALLING JOINT AND CORNER PROFILES

INSTALLING CORNER PROFILES

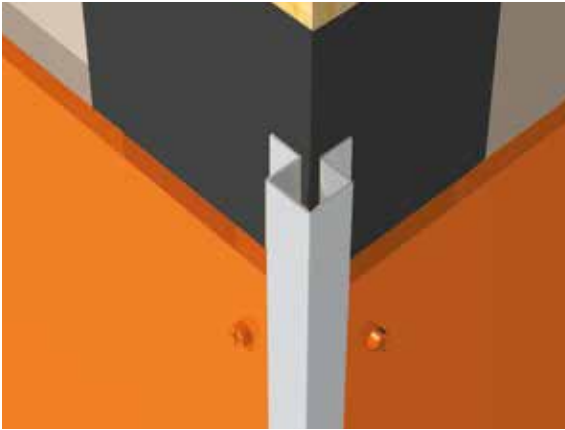

EPDM must cover the entire wooden batten.

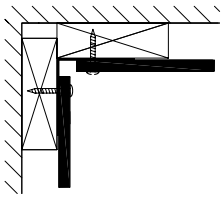

At inside corners install a strip of EPDM behind the panels.
Or use a metal fitting to seal the corner.

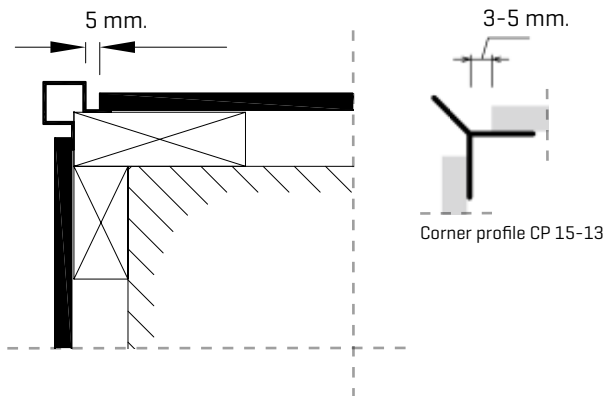

Corner profile CP 15-18-33 / CP 15-25-40
to ease the installation and prevent the profile from sliding a dab of glue or a small piece of double sided tape can be used to secure the profile temporarily.

Remember to use a 5 mm expansion gap between all profiles. (Thermal expansion).



INSTALLING JOINT PROFILES



EPDM must cover the entire wooden batten

When joint profiles are installed allow for 10 mm gaps between panels.

Use a spacer block to get even joints.

1. Vertical/Horizontal profile: FP 6-30
2. Horizontal profile: HFP 7-30
3. Horizontal profile: HP 7-30

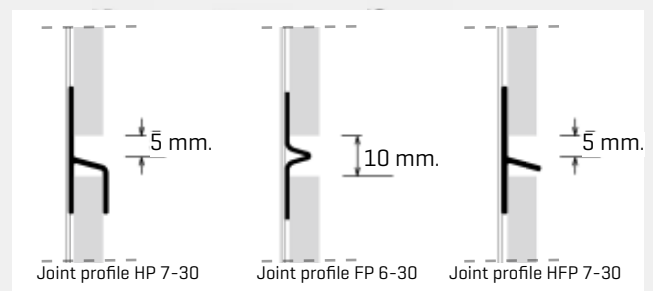

Joint profile HP 7-30

Joint profile FP 6-30

Joint profile HFP 7-30

INSTALLATION WITH ELEMENTS

INSTALLATIONS USING CORNER ELEMENTS OR U-ELEMENTS

CORNER ELEMENT:

At corners we recommend using corner elements or corner profiles to get nice and straight corners.

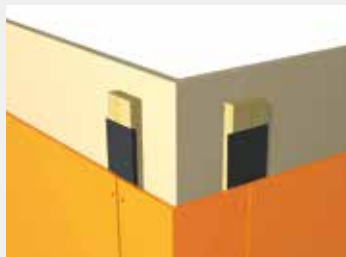

The EPDM must cover the entire wooden batten.

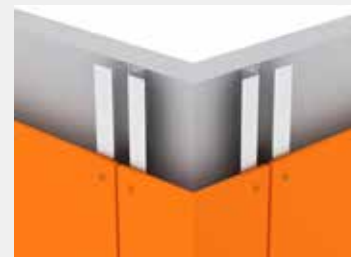

Corner elements on metal battens

The figures show the principles for battening behind U-elements. The wings of the U-elements are battened in the same way as for L-elements. The bottom of the U-element is battened as shown below.

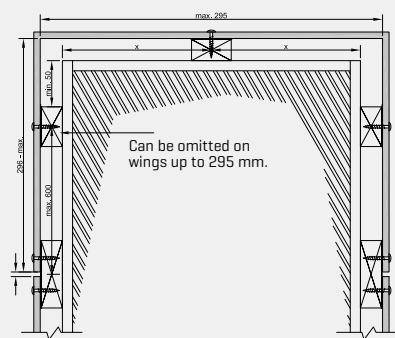

Bottom up to 295 mm.

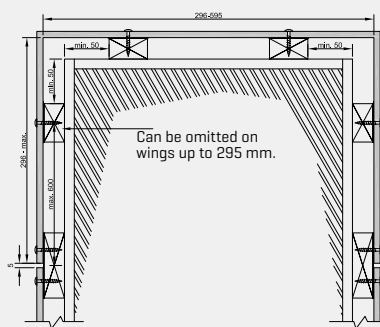

Bottom between 296-595 mm.

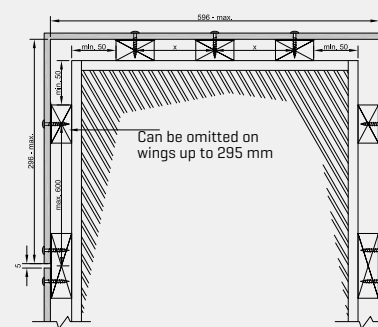

Bottom larger than 595 mm.

BATTENING AND FIXINGS:

For elements with wings up to 295 mm it is enough to place one batten along the two edges. For larger wings, use at least one extra batten towards each side of the corner.

For U-elements with a bottom part up to 295 mm wide, one batten placed under the middle of the panel is used. If the bottom part is up to 595 mm two battens are used. If the bottom gets wider than 595 mm use three battens as indicated in the figure.

Do not place battens closer to the corner than 50 mm.

Maximum batten distance is 600 mm. The distance between fixing points along the batten must not exceed 300 mm.

See figures.

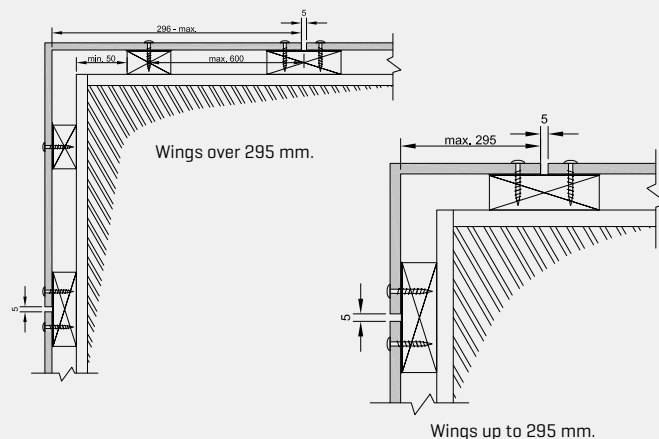

The figures show the principles for battening behind L-elements.

Maintenance

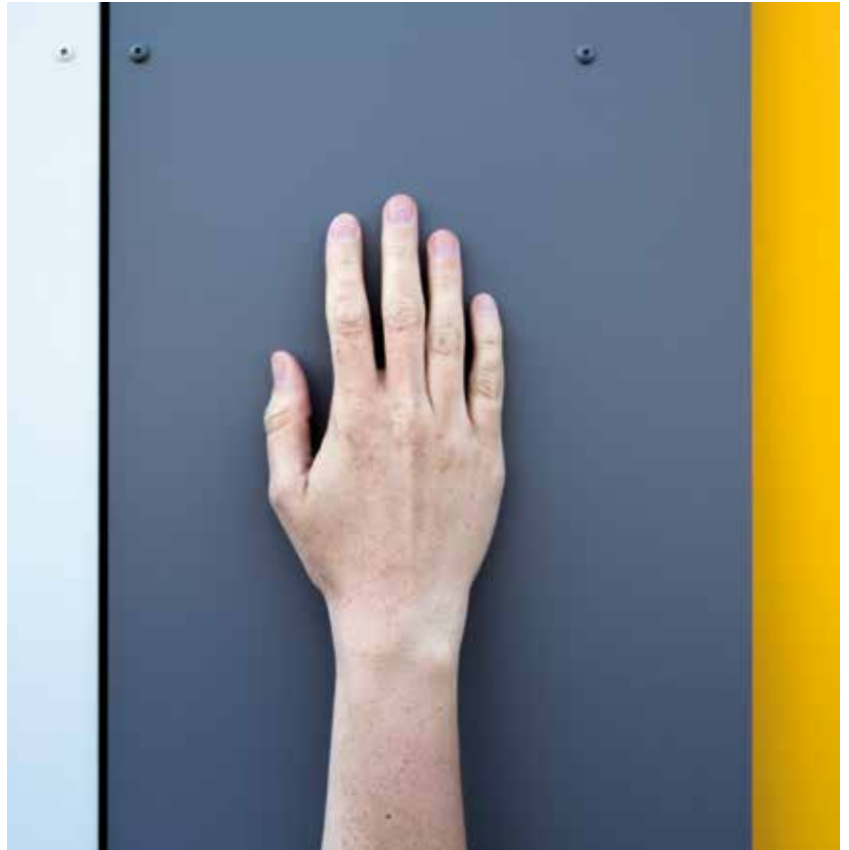

CLEANING

CHOOSING A CLEANING AGENT

All STENI panels can be cleaned with most cleaning agents on the market intended for use on buildings [e.g. house wash cleaner].

Highly alkaline solutions [pH>10] should not be used as it may dull the panels surface. 

Choose a cleaning product based on what you want to wash off. Follow the usage instructions for the cleaning product carefully. If you are uncertain, we recommend performing a test in a discrete location, or contact a professional cleaning company. STENI Nature and STENI Terra can be primed and impregnated to make the surface easier to keep clean.

HIGH-PRESSURE WASHING

All STENI panels can be cleaned with a high-pressure washer up to 100 bar and temperatures up to 80 °C. Hold the nozzle should at least 20-30 cm from the surface. High-pressure washing at high temperatures produces good results, saves the environment and is preferable to excessive use of chemicals. When using high-pressure washers on STENI Nature and STENI Terra, there is always a risk that some of the surface stone could loosen. Exercise caution.

AFTER INSTALLATION

Dust from cutting and drilling must be removed immediately. [See below] All labels etc. should be removed immediately after installation. Remove any residual adhesive with a suitable cleaning agent.

When the facade installation and all other dusty work is complete, the facade should be cleaned using a suitable alkaline cleaning agent. Use a high-pressure washer and plenty of water.

DUST FROM CUTTING AND DRILLING

Dust from cutting and drilling must be removed immediately. We recommend using tools connected to a dust extractor. Any remaining dust is removed using compressed air and a soft dry brush. Dust that can not be blown away can be removed using a microfiber cloth dampened with an alkaline cleaning agent.

PAINT, GRAFFITI, VARNISH, STAIN ETC.

For proper removal of paint, graffiti, etc. it is important to determine what type of paint products have been used and choose cleaning agents accordingly. Improper use or unsuitable products may cause the paint to penetrate deeper into the panel.

Always contact a professional cleaning company before attempting to remove paint products [see steni.com for video showing graffiti removal].

Maintenance



OIL, GREASE, SOOT ETC.

Use petrochemical degreasing agents or similar product designed for use on painted surfaces [cars etc.] Follow the instructions carefully. Rinse the façade with a highpressure washer, preferably in combination with hot water. Use plenty of water.

ALGAE, MOSS, DIRT ETC.

Use an alkaline or pH-neutral cleaning agent intended for the task. Follow the usage instructions carefully. Rinse clean with a high-pressure washer. Use plenty of water.

DISINFECTION

STENI Colour and STENI Vision are suitable as surfaces that require regular disinfection (food industry, operating rooms etc.)

SACIDIC CLEANING AGENTS

STENI Nature and STENI Terra contain limestone, which can become discoloured if you use acidic cleaning agents.

MAINTENANCE

Pollution, temperature fluctuations, climate and wind will wear on the facade. Steni facade panels and facade systems require an annual visual inspection to ensure optimal longevity and a stable facade with a great, exclusive appearance year after year.

The warranty regulations require regular and necessary maintenance of the facade. It is a prerequisite that the building owner establishes a maintenance plan for regular and periodic maintenance adapted to the building. The following points should be on the annual control schedule to ensure that necessary maintenance is performed in a timely manner:

- Check if the facade needs cleaning. The joints and areas around windows, ventilation grates etc. are specially exposed.
- Check if the panels are intact and without cracks or damages. Damaged panels must be replaced
- Check if the fixings are intact. Replace loose or missing fixings.
- Check that the ventilation behind the panels is not blocked and that the constructions does not show any outward signs of moisture damage.

Tips for safe planning and design



IMPORTANT INFORMATION

Design of the façade system must always be in accordance with applicable national and local regulations. Designers are responsible for selecting products and solutions that satisfy these requirements, both individually and as a complete system.

WINDLOADS

The following formula is used to calculate the dimensional wind load capacity for different panel dimensions:

$$q_{Rd} [N/m^2] = N_f \cdot F_{Rd}$$

hvor

N_f the number of fixing points per m² (see table 1a/1b)
 F_{Rd} is the design pull-out capacity of the screw
 (see TDS for the screw)

Calculation of the fixing point and batten distance

Wind load depends on the shape and height of the building, as well as the terrain surrounding the building.

The design wind load on the facade [qsd] can be calculated according to the rules in EN 1991-1-4.

The dimensioning criterion is: $q_{Rd} \geq q_{Sd}$

The required number of fixing points per m² is thus as follows:

$$N_f \geq q_{Sd} / F_{Rd}$$

Table 1a shows the minimum number of fixing points per m² for different panel widths and horizontal installation.

Table 1b shows the minimum number of fixing points for vertical installation. For both tables, vertical battens and standard drill patterns apply.



Panel width in mm	Number of fixing points per m ² [N _f]		
	Batten distance in mm		
	300	400	600
295-395	18,8	14,4	10,1
396-630	17,7	13,6	9,5
631-930	15,9	12,3	8,6
931-1195	15,5	11,9	8,3

Tabell 1a. Number of fixing points for horizontal installation

Panel width in mm	Number of fixing points per m ² [N _f]			
	Screw distance in mm *		Screw distance in mm**	
	240	300	240	300
295-395	23,1	18,8
396-595	15,3	12,5	23	18,7
596-930	14,7	11,9
931-1195	11,4	9,33

Tabell 1b. Number of fixing points for vertical installation

* - Battens along panel edge ** - Batten along panel edge and field *** - Not recommended

Tips for safe planning and design



DIRECTION OF THE PANELS

For dark coloured STENI Colour panels, for aesthetic reasons, we recommend to mount the panels in the same direction [see arrows --> on the back of the panels].

Steni Colour -> Klasse A Class A B-s1,d0 07.09.2021 11:17

FIRE

FIRE CLASSIFICATION

All Steni Colour, Nature and Steni Vision panels are classified as B-s1, d0 according to EN 13501-1.

In addition, a number of large-scale fire tests have been carried out, ensuring that the products can also be used in tall buildings [over 8 storeys]. Tests have been performed in accordance with SP FIRE 105, NFPA 285 and ULC-S134. For a complete list of performed fire tests and ratings refer to our website steni.com.

Tips for safe planning and design

VENTILATED CLADDING WITH TWO-STAGE SEALING

AIR GAP REQUIREMENTS

Adequate drainage and ventilation of the cavity behind the façades panels is important for preventing the underlying structure from becoming damp.

When installing STENI panels with an open 5 mm joint, a 23 mm thick batten will achieve satisfactory ventilation. A corresponding air gap is also used for exterior post-insulation.

In areas with high levels of precipitation and pounding rain additional protection against water penetration is required. In in such areas we recommend using min. 36 mm thick battens and a one of our joint profiles. See also SINTEF Building and Infrastructure Design Guide 542.003. 

When using horizontal battens, we recommend using a ventilated metal profile. It is perforated to ensure airflow behind the façade. The batten is also designed to prevent standing water in the perforations that could be directed towards the underlying structure.

When using horizontal battens, it is important to stop horizontal ventilation at the corners to prevent wind pressure from passing freely around the corners. Similarly, large façades should be divided into fields. When using horizontal battens, we recommend using the joint profiles in the vertical joints to prevent unnecessary water intrusion regardless of the amount of rainfall in the area.

For finishing along foundations, cornices, windows and doors, battens and fittings must be installed so that the air gap is not sealed. We recommend an air gap of minimum 40-50 cm² per running metre of facade at all horizontal terminations. [see figures below]

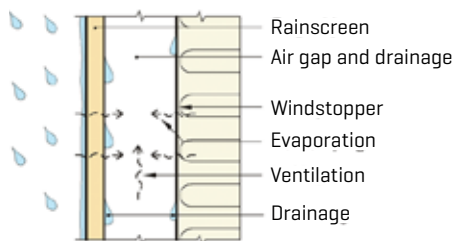

Two-stage sealing principle

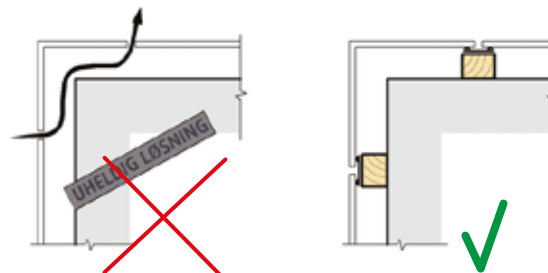

Correct and incorrect corner solution using horizontal battens [horizontal cross-section]



Tips for safe planning and design

DETAILS AND TERMINATIONS

INSTALLING AROUND WINDOWS AND DOORS

Various combinations of fittings, corner profiles and panel solutions are possible.

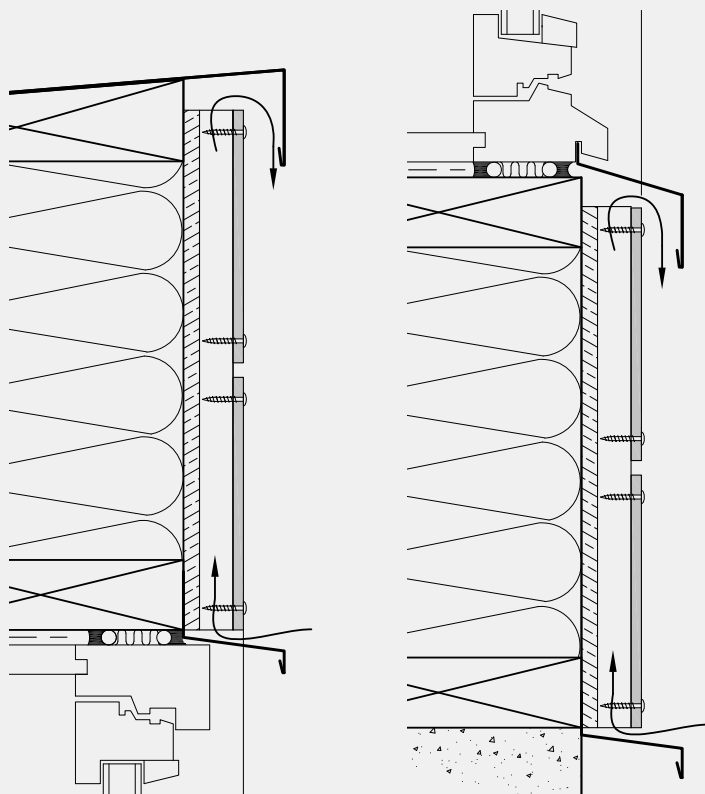

Vertical cross-section that shows the correct implementation to ensure ventilation along foundations, windows, doors and cornices. Min 40-50 cm²/m

Corner element combined with fittings
[horizontal cross-section]

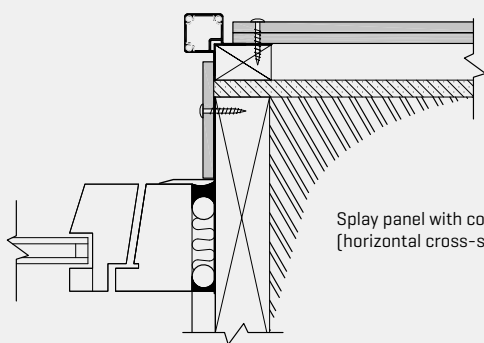
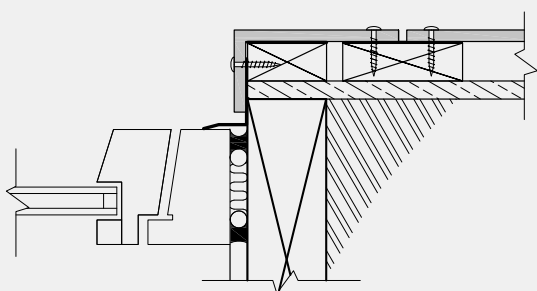

Splay panel with corner profile
[horizontal cross-section]

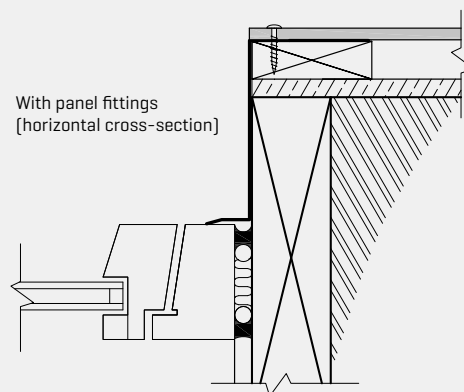

With panel fittings
[horizontal cross-section]

STENI AS

Lågendalsveien 2633,
3277 Steinholt
T 33 15 56 00,
E info@Steni.com



- Sea of surfaces -

Download in different languages



Dansk



Suomalainen



Svenska



English



Français



Nederlands



Polskie

Steni fasadeløsninger gir unike og varige arkitektoniske uttrykk – med høy kvalitet. Et hav av tilgjengelige overflater, fra fargede glatte i ulike glanser, til overflater med knust naturstein i mange farger og graderinger – og printede overflater med mulighet for individuell design. Steni gir deg muligheten til å utforme bygningen akkurat slik du ønsker den!

Siden etableringen i 1965 har Steni levert mer enn 48 millioner kvadratmeter kvalitetsplater til hele verden.